

GS-A-XPOL-0001-V2-21



Technical Data		
2G, 3G, 4G, 5G - MiMo & Diversity antenna, wall mount, pole mount and windows mount		
	Frequency Range	698 - 960 MHz 1710 - 2700 MHz 3400 - 3800 MHz
	Gain (max) Port 1&2	3 dBi
	Operational bands	2G / 3G / 4G / 5G
	VSWR Port 1 & 2	≤ 2.5:1 (over 95% of the band)
	Power Max.	20 W
	Impedance	50 Ω
	Polarisation	Cross Polarised
Mechanical Data		
	Dimensions (HxWxL)	247 mm x 157 mm x 88 mm
	Operating temp	-40°C .. +70°C
	Material	ASA Brilliant White (UV stable)
	Cable	2x 5 m Twin HDF 195
	Connector	2x SMA (male) 
	Wall / pole mount	
	RoHS compliant	

GS-A-XPOL-0001-V2-21

Figure 1; Mechanical drawings

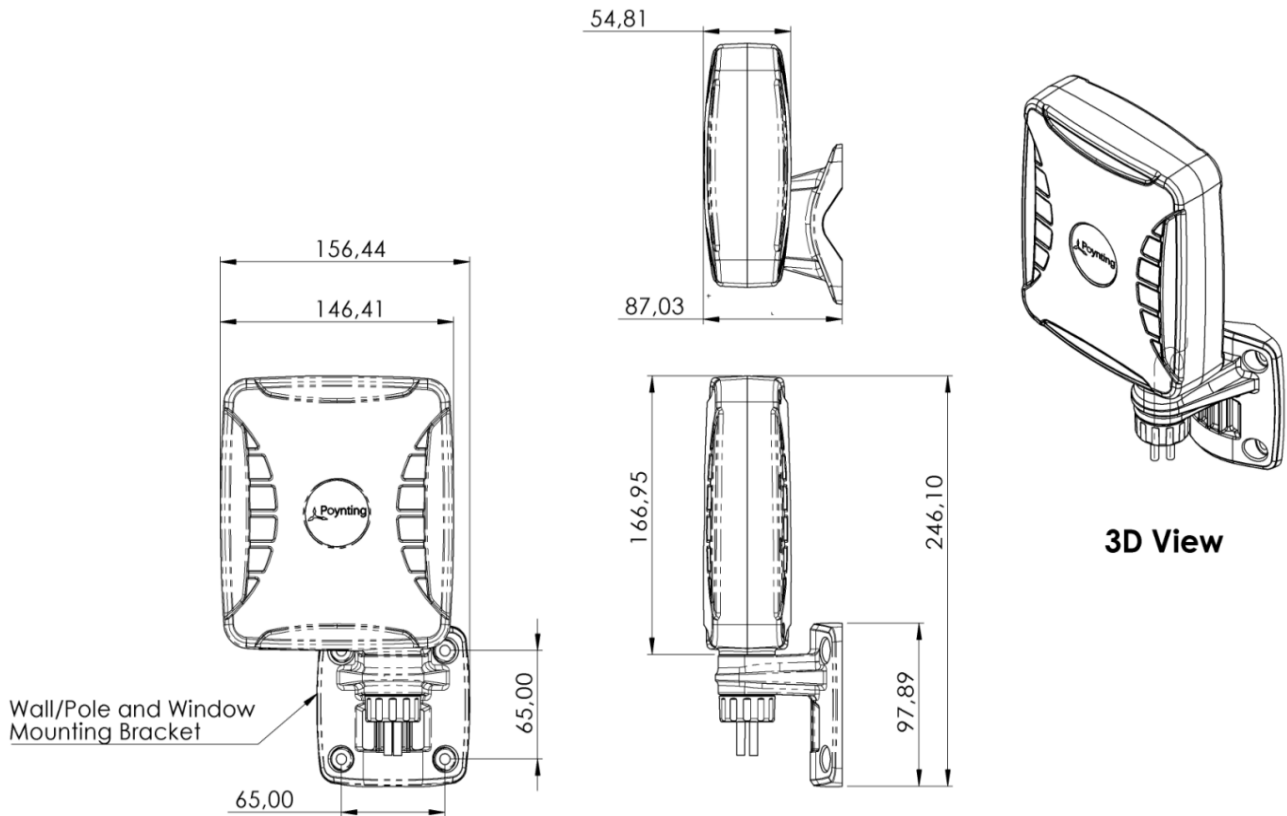

Voltage Standing Wave Ratio (VSWR):

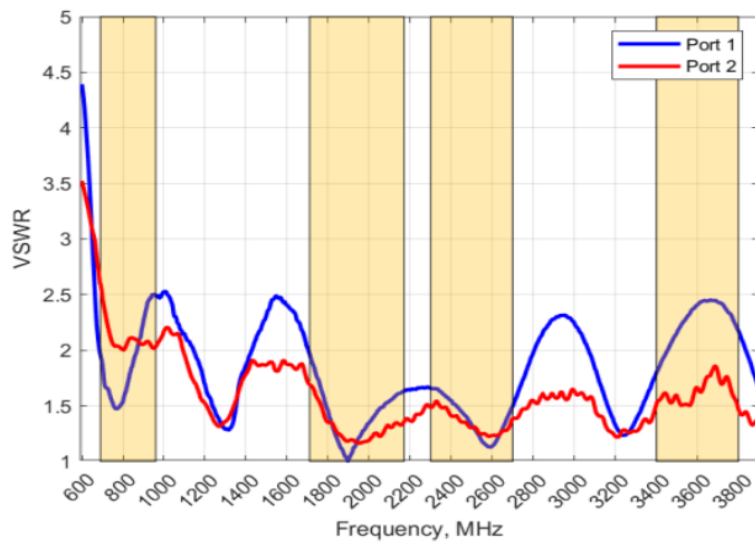

* measured with 5m cable

GS-A-XPOL-0001-V2-21

Gain in dBi:

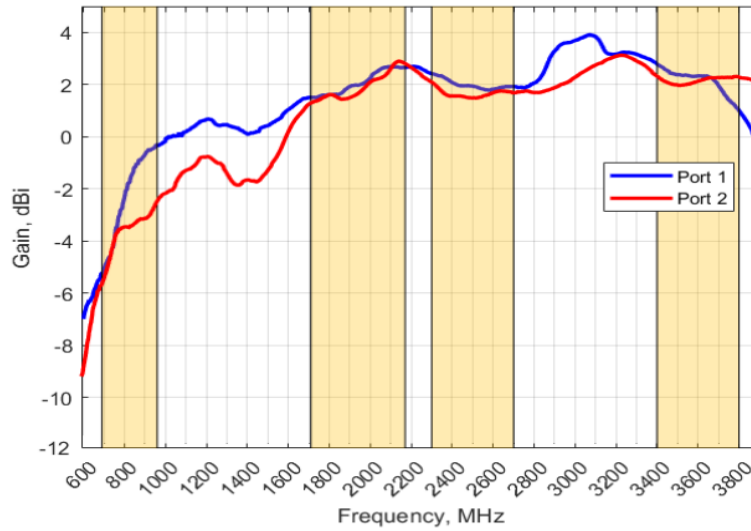

Azimuth (Top View)

Elevation (side View)

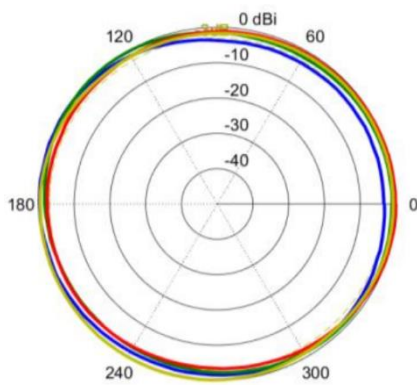

- 690 MHz
- 760 MHz
- 860 MHz
- 960 MHz

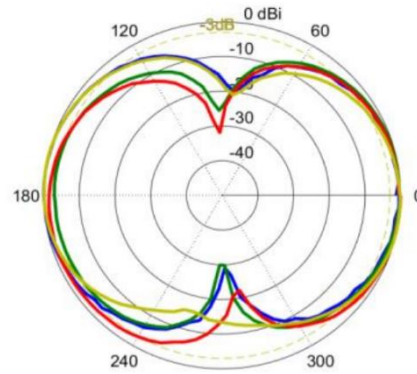

- 690 MHz
- 780 MHz
- 870 MHz
- 960 MHz

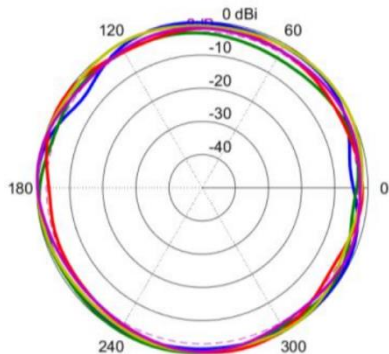

- 1710 MHz
- 1850 MHz
- 1950 MHz
- 2050 MHz
- 2170 MHz

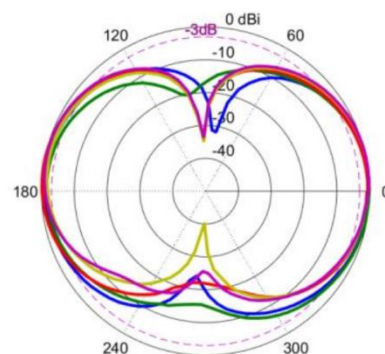

- 1710 MHz
- 1850 MHz
- 1950 MHz
- 2050 MHz
- 2170 MHz

GS-A-XPOL-0001-V2-21

