

GS-ANT-325



Technical Data	
3G, 4G, 5G - MiMo & Diversity antenna, wall mount, desk mount, mast mount	
Frequency Range	698 - 960 MHz 1710 -3800 MHz
Gain	698 - 960 MHz 2 dBi 1710 -2170 MHz 5 dBi 2200 -3800 MHz 4 dBi
Operational bands	2G / 3G / 4G / 5G
Efficiency	> 50%
Correlation coefficient	< 0.2
Power Max.	20 W
Impedance	50 Ω
Mechanical Data	
Dimensions (HxWxL)	155 mm x 155 mm x 75 mm
Operating temp	-30°C .. +80°C
Ingress Protection	IP65
Material	ASA (RAL 9010 – pure white)
Cable	2x ca. 5 m: CS29 (double shielded RG58)
Connector	2x SMA (male) 
Wall / desk / mast mount	
RoHS compliant	

GS-ANT-325

Figure 1; Mechanical drawings

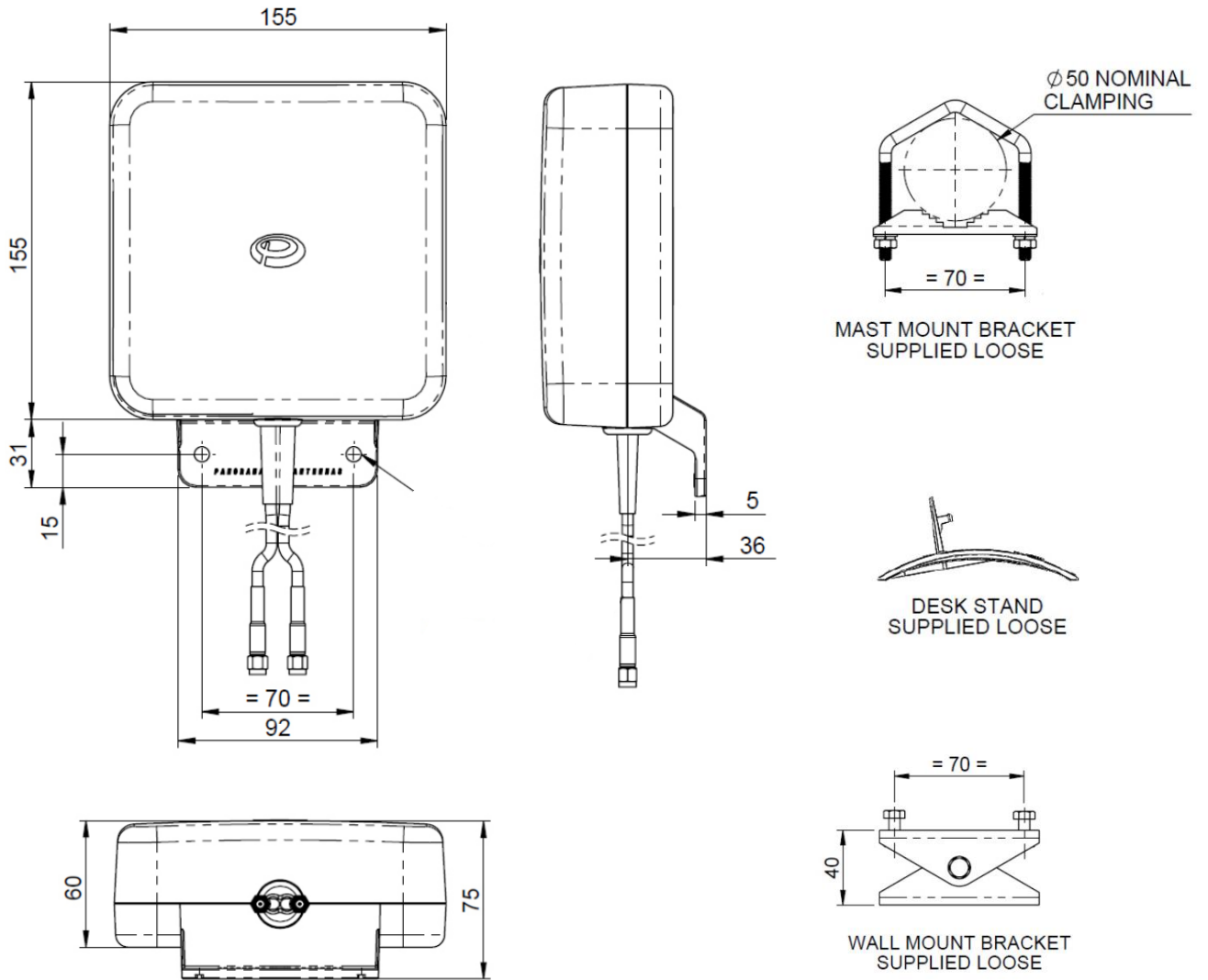

GS-ANT-325

Typical VSWR Elements 1 & 2 *

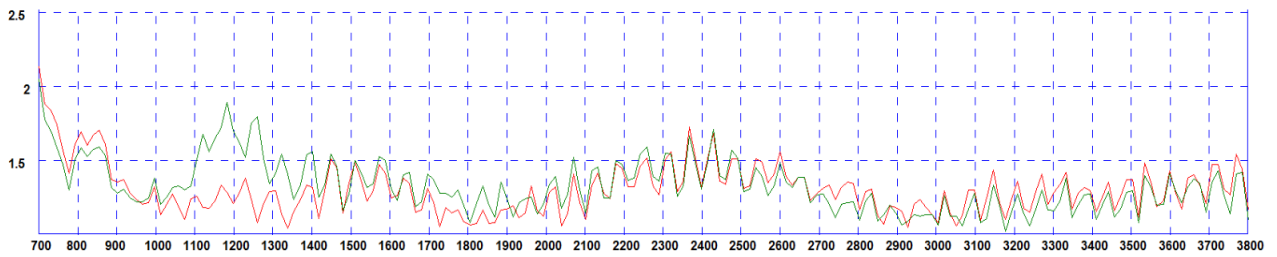

*VSWR Measured with 5m (16') of CS29 cable

Typical VSWR Elements 1 & 2 *

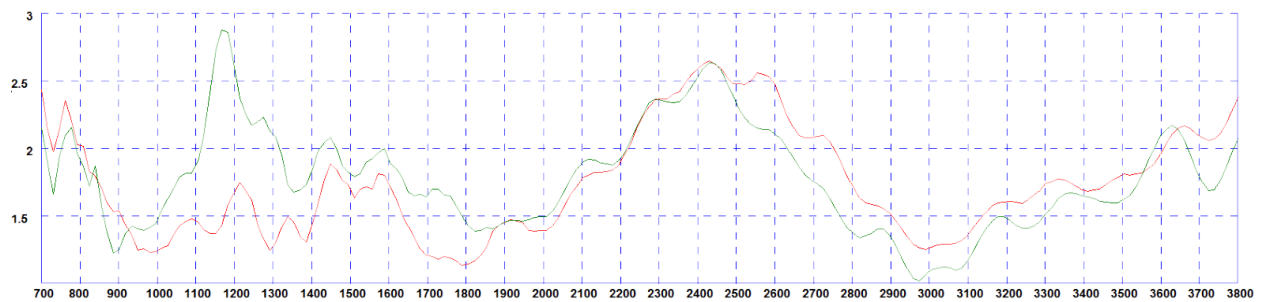

*VSWR measured without cable

Typical Isolation Elements 1 & 2 *

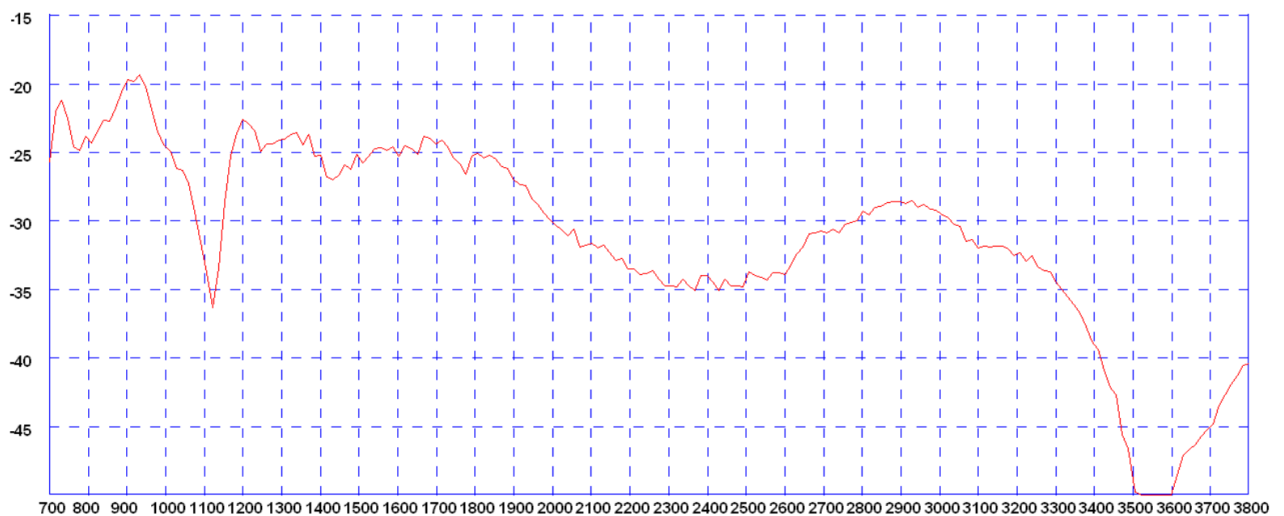

* Isolation measured with 5m (16') of CS29 cable

GS-ANT-325

3D Gain Plot (750MHz)

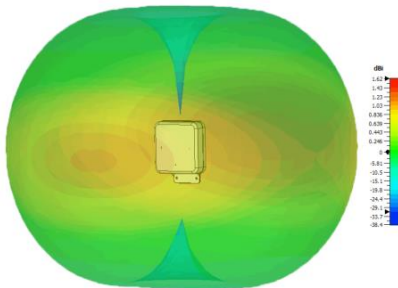

3D Gain Plot (850MHz)

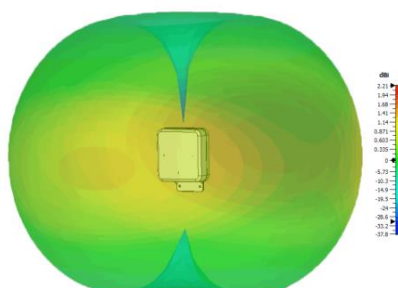

3D Gain Plot (950MHz)

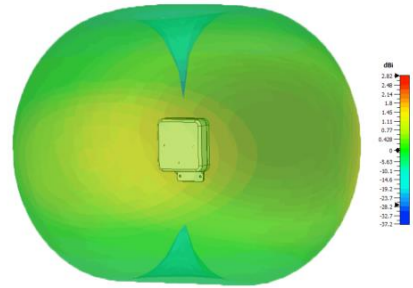

3D Gain Plot (1800MHz)

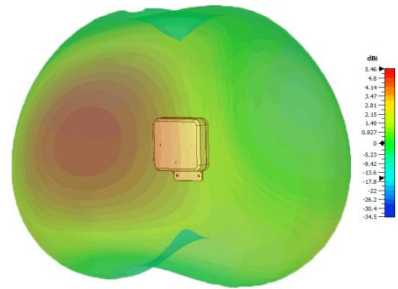

3D Gain Plot (1900MHz)

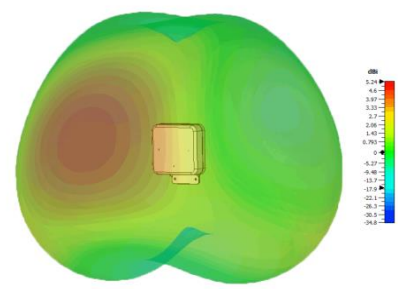

3D Gain Plot (2100MHz)

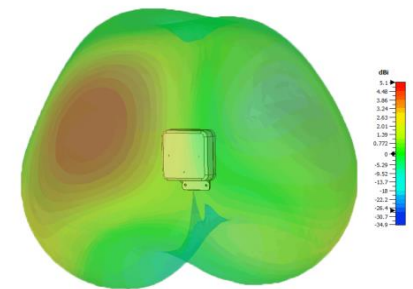

3D Gain Plot (2600MHz)

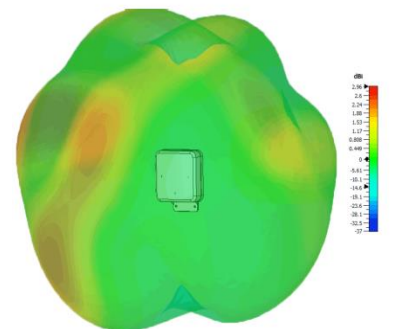

3D Gain Plot (3600MHz)

