

# GS-ANT-33-700-01



Technical Data		
<b>Tetra</b> - Ground Plane Independent antenna, adhesive mount		
	Frequency Range	380 - 470 MHz
	Peak Gain	2.8 dBi
	Average Gain	-3.6 dB
	Bands	390 MHz, 420MHz, 460MHz
	VSWR	≤ 2.0:1
	Return Loss	~ -11.5 dB
	Power Input Max.	50 W
	Impedance	50 Ω
	Polarisation	Linear
Mechanical Data		
	Dimensions (HxWxL)	112.5 mm x 60 mm x 11.3 mm
	Operating temp	-40°C .. +85°C
	Material	PC/ABS Black (UV stable)
	Cable	2.50 m RG174
	Connector	FME (female) 
	Adhesive Mount	
	RoHS compliant	

# GS-ANT-33-700-01

Figure 1; Mechanical drawings

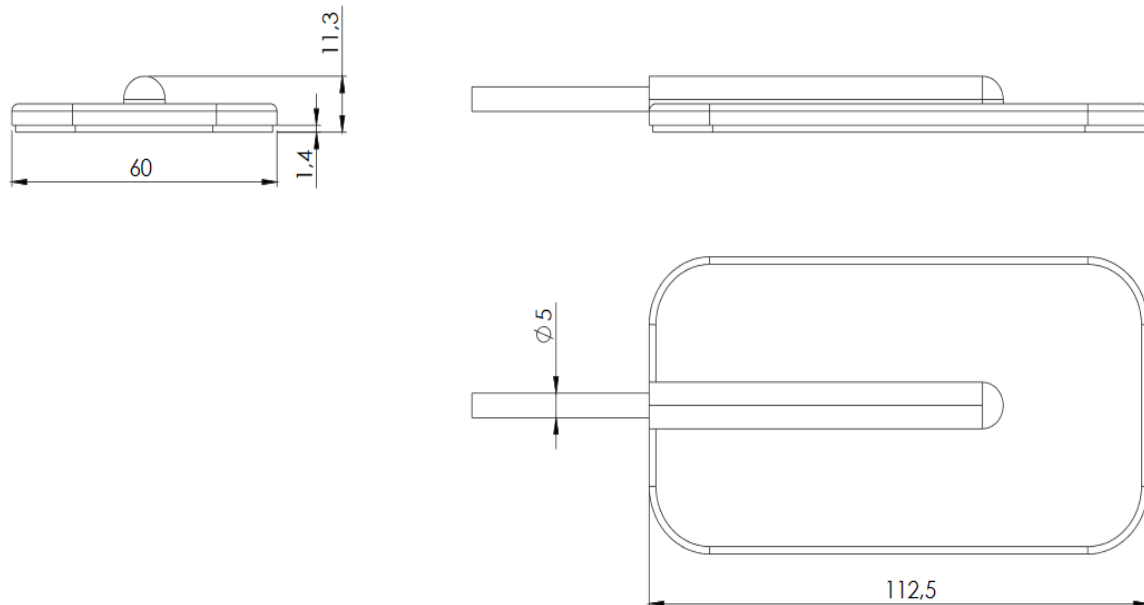

Return Loss in dB:

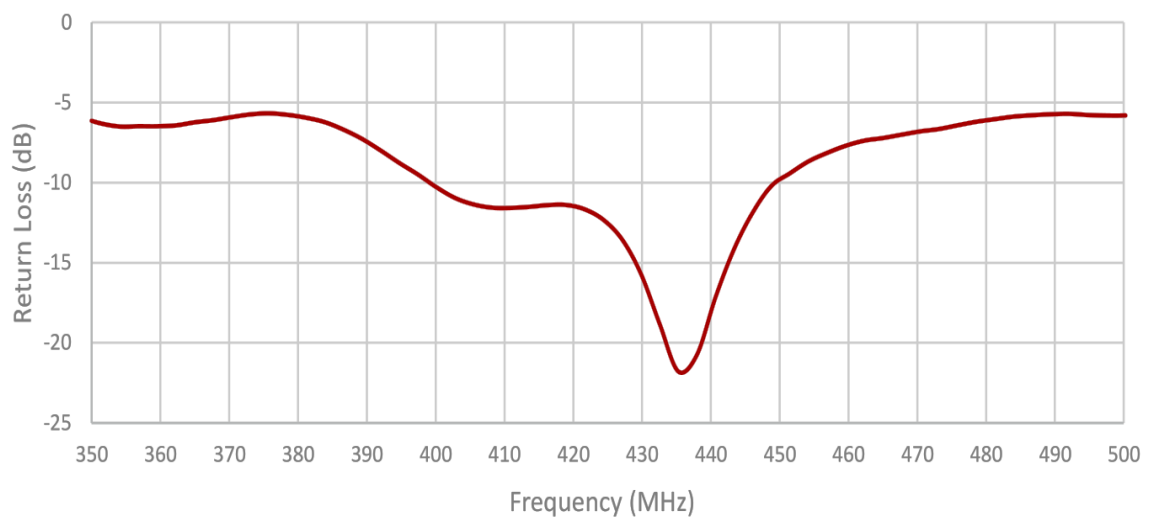

# GS-ANT-33-700-01

## Voltage Standing Wave Ratio (VSWR):

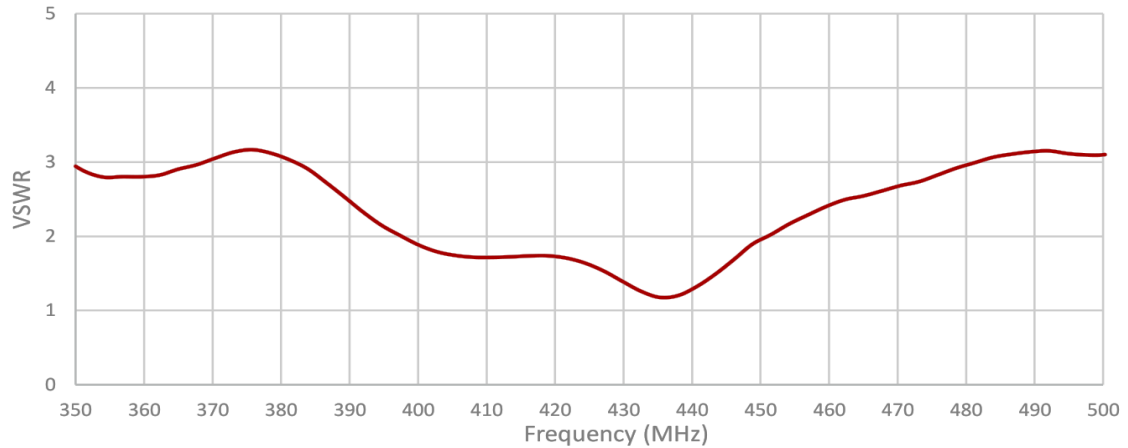

\* measured with 2m cable

## Peak Gain in dBi:

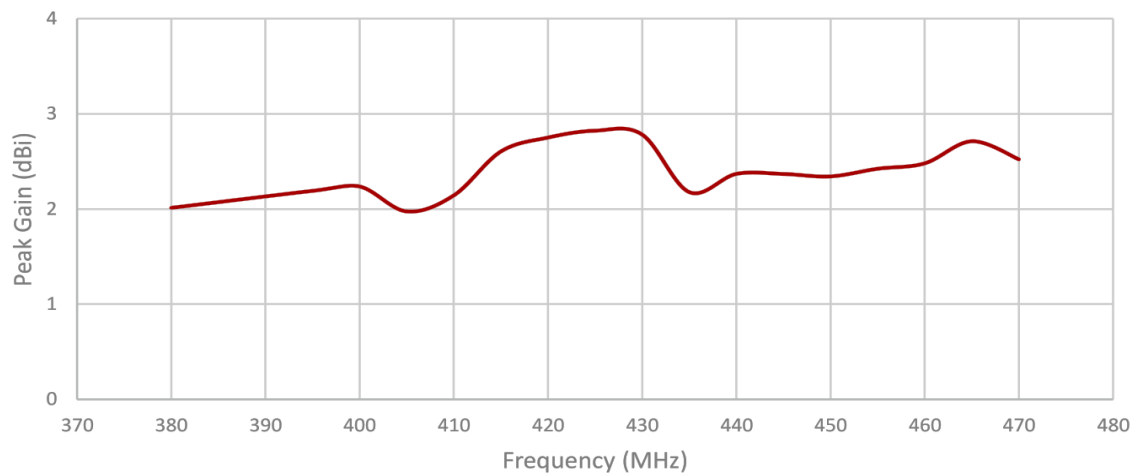

## Average Gain in dB:

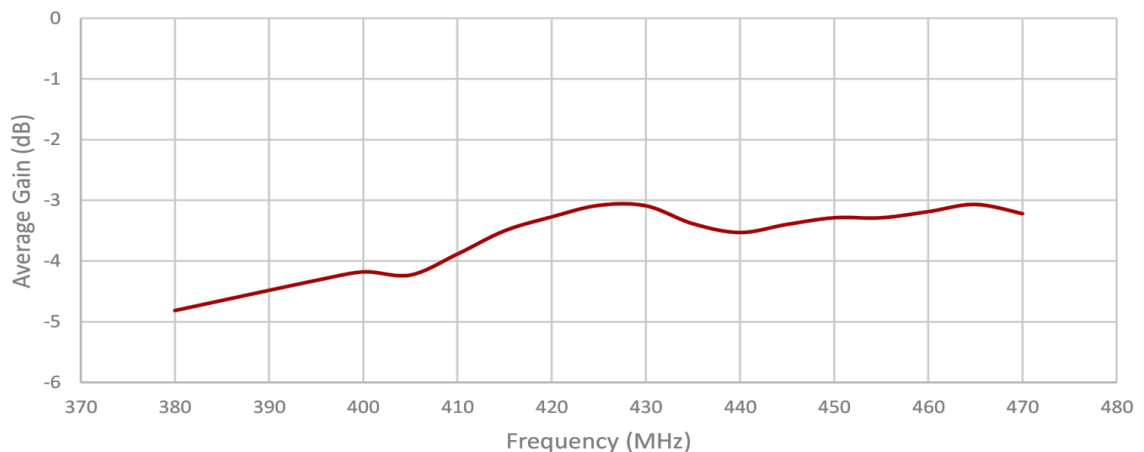

# GS-ANT-33-700-01

Efficiency (%):

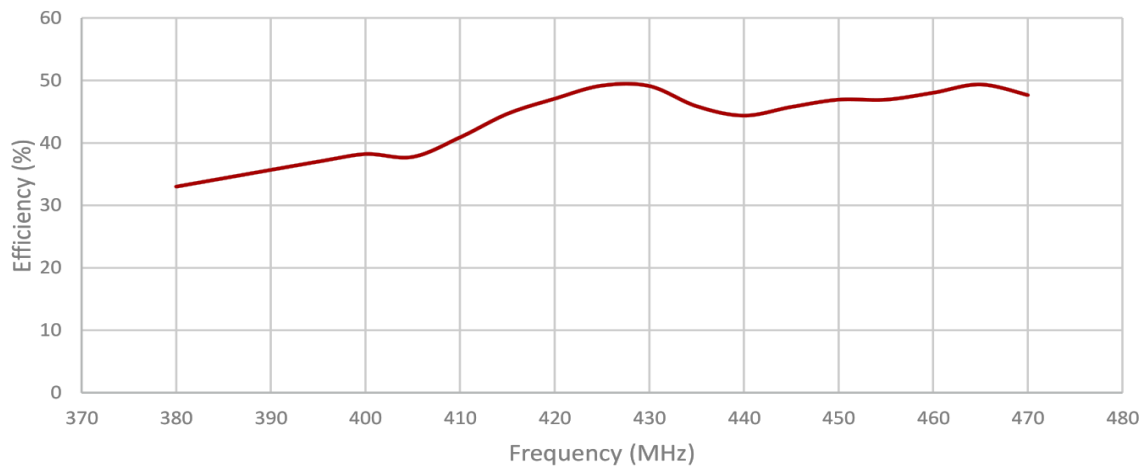

Radiation pattern:

