

# GS-XPOL-2-5G-01

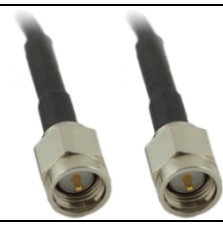

Technical Data	
<b>2G, 3G, 4G, 5G</b> - MiMo & Diversity antenna, wall mount, pole mount	
Frequency Range	698 - 960 MHz 1710 - 2700 MHz 3400 - 3800 MHz
Gain (max) Port 1&2	698 - 960 MHz      9 dBi 1710 - 2700 MHz    10 dBi 3400 - 3800 MHz    11 dBi
Operational bands	2G / 3G / 4G / 5G
VSWR Port 1 & 2	≤ 1.5:1 (over 95% of the band)
Power Max.	20 W
Impedance	50 Ω
Nominal Polarisation	+/- 45 deg Vertical
Mechanical Data	
Dimensions (HxWxL)	290 mm x 265 mm x 155 mm
Operating temp	-40°C .. +80°C
Material	ASA Brilliant White (UV stable)
Cable	2x 5 m Twin HDF 195
Connector	2x SMA (male) 
	Wall / pole mount
	RoHS compliant

# GS-XPOL-2-5G-01

Figure 1; Mechanical drawings

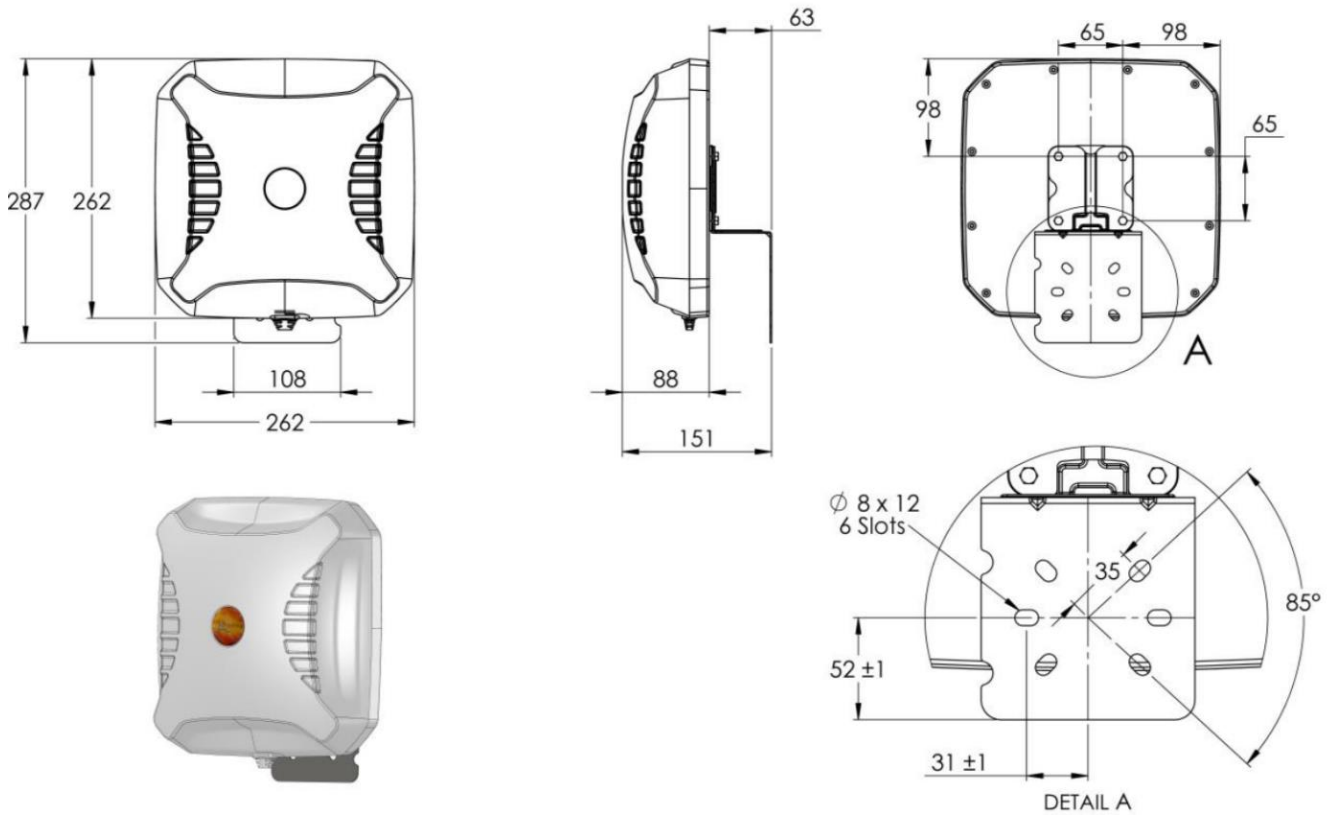

## Voltage Standing Wave Ratio (VSWR):

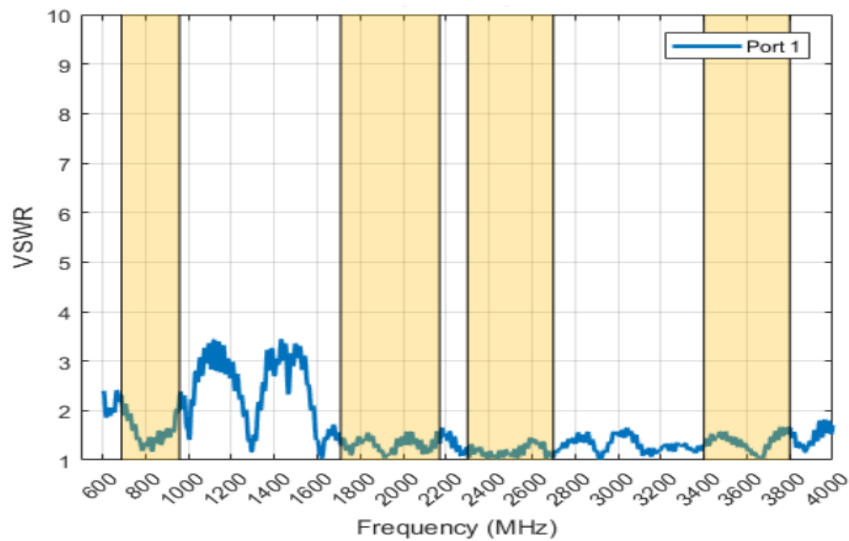

\* measured with 5m cable

# GS-XPOL-2-5G-01

Gain in dBi:

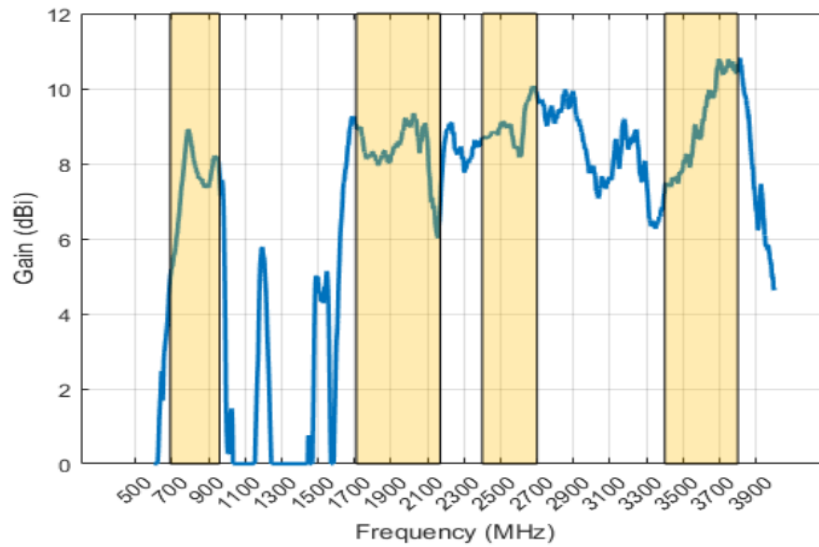

Azimuth (Top View)

Elevation (side View)

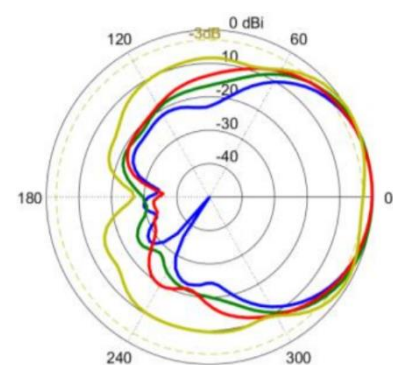
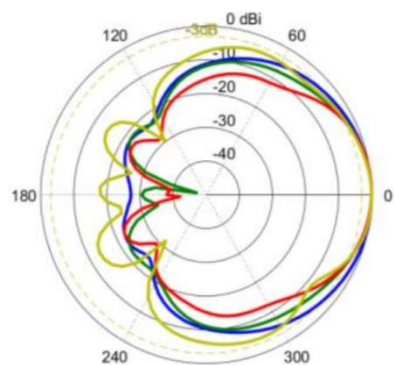
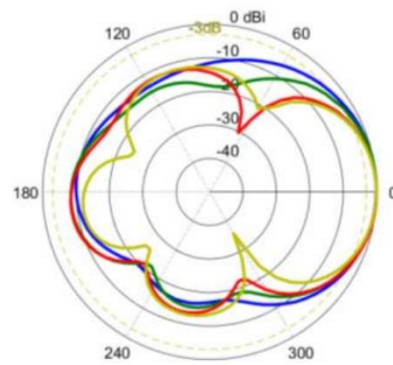
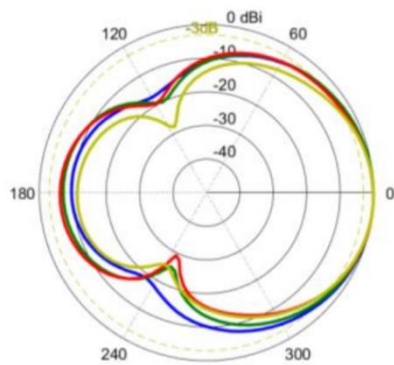

# GS-XPOL-2-5G-01

