

GS-XPOL-2

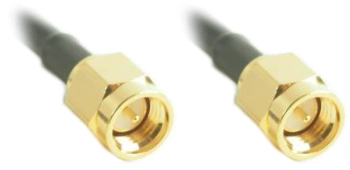

Technical Data	
2G, 3G, 4G - MiMo & Diversity antenna, wall mount, pole mount	
Frequency Range	698 - 960 MHz 1710 - 2170 MHz 2300 - 2700 MHz
Gain (max) Port 1&2	698 - 960 MHz 8 dBi 1710 - 2170 MHz 6.5 dBi 2300 - 2700 MHz 9 dBi
Operational bands	2G / 3G / 4G
VSWR	≤ 2.0:1 (over 90% of the band)
Power Max.	10 W
Impedance	50 Ω
Polarisation	0° and 90°
Mechanical Data	
Dimensions (HxWxL)	290 mm x 265 mm x 155 mm
Operating temp	-40°C .. +70°C
Material	ABS –Cool Gray (Halogen Free)
Cable	2x 5 m Twin HDF 195
Connector	2x SMA (male) 
	Wall / pole mount
	RoHS compliant

GS-XPOL-2

Figure 1; Mechanical drawings

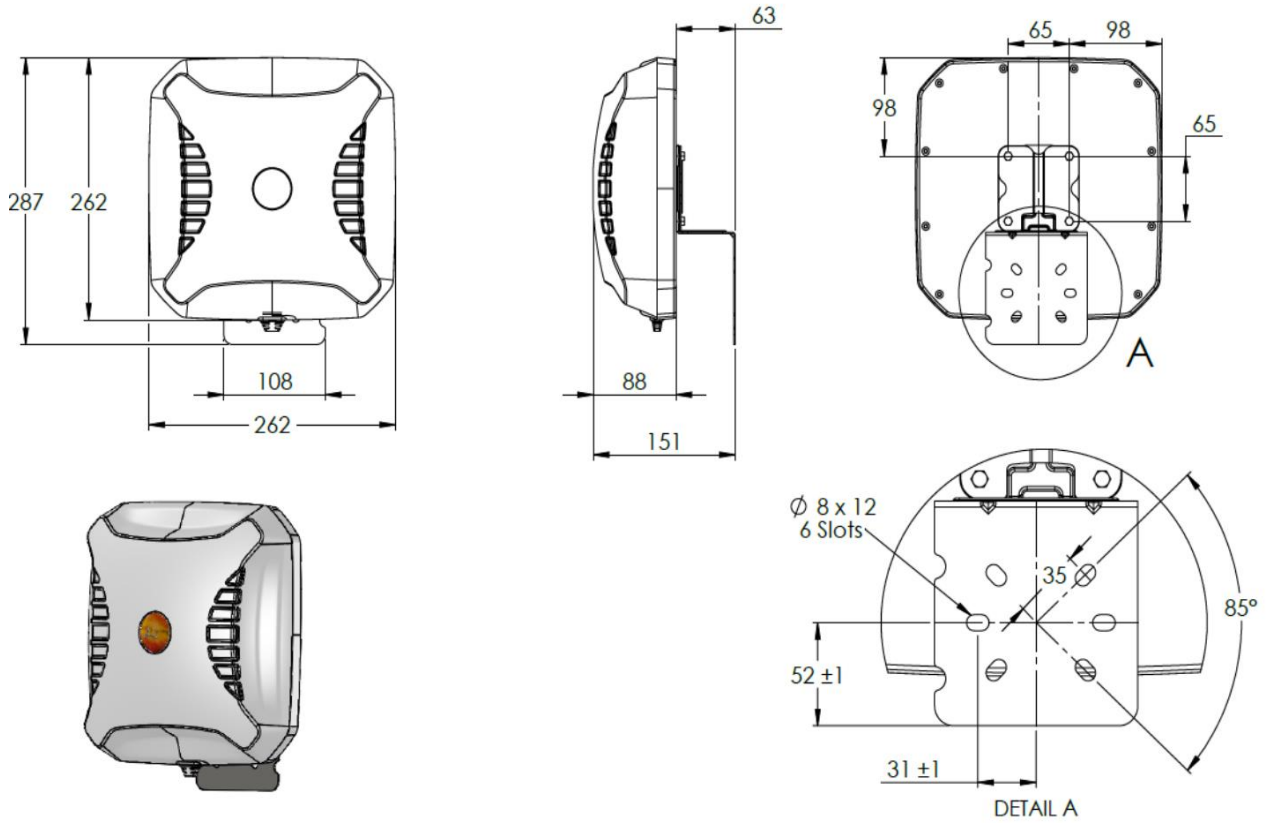

Voltage Standing Wave Ratio (VSWR):

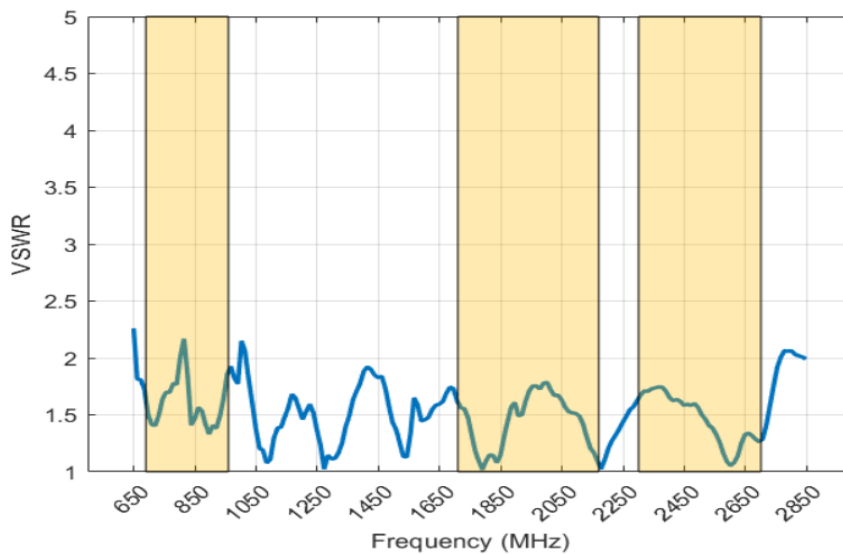

* measured with 5m cable

GS-XPOL-2

Gain in dBi:

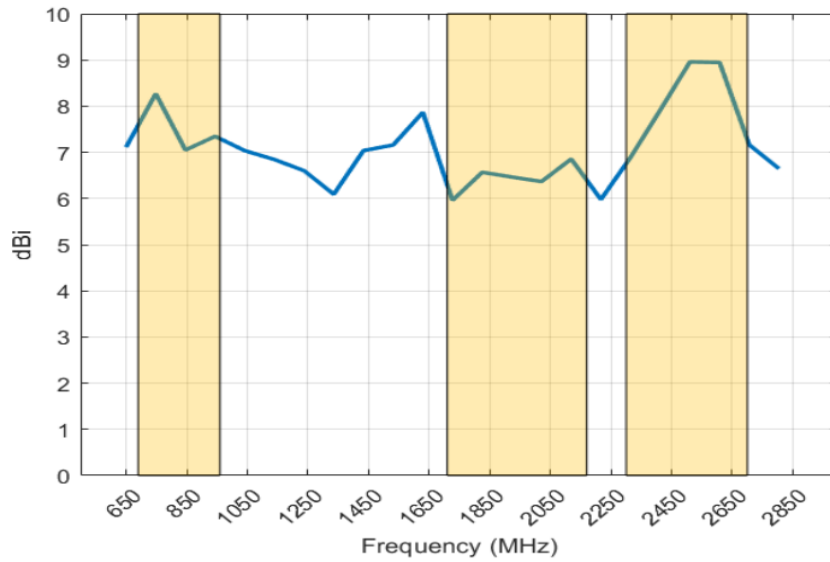

Azimuth (Top View)

Elevation (side View)

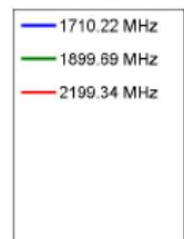
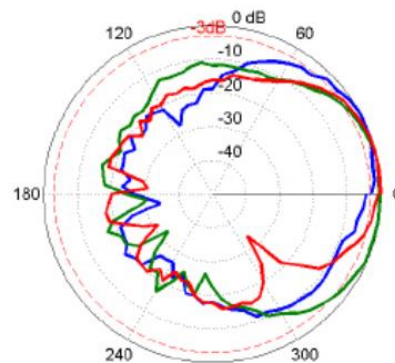
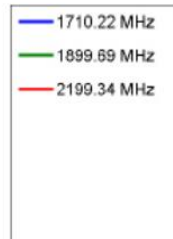
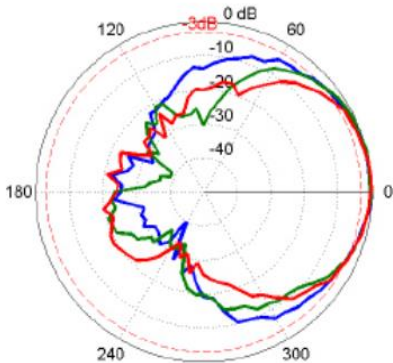
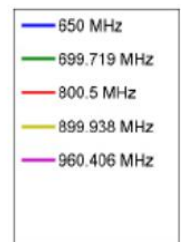
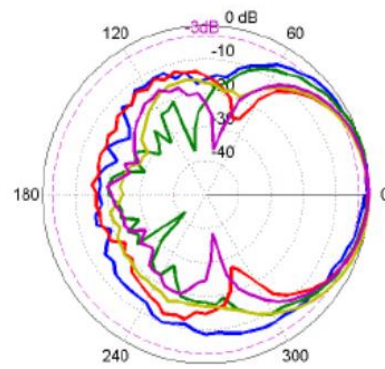
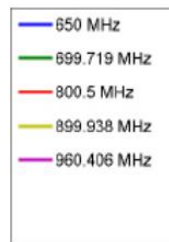
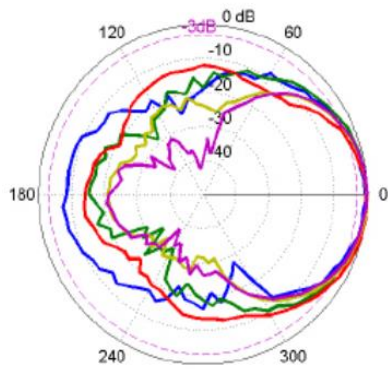

GS-XPOL-2

